

AF-38 Series



Features

- Package:5.0*5.4*1.1mm
- Viewing angle:120° RGBW LED
- High radiant intensity.
- Soldering methods: Reflow soldering
- RoHS compliant
- EU REACH compliant
- Pb-free

Description

- The HoneBright “AF-38 Series” package has high efficacy, low power consumption and a compact form factor. These features make this package an ideal LED for all lighting applications.

Applications

- LED Strip Light
- General Lighting
- Smart Lamp Application
- Architectural Lighting
- Street Lamps
- Other Lighting

Contents

Product Code Description.....	3
Package Dimension.....	4
Absolute Maximum Ratings.....	5
Electro-Optical Characteristics.....	5
Chromaticity Bins.....	6~9
Brightness Groups.....	10
Forward Voltage Groups.....	11
Wavelength Groups&Table of Color Rendering Index.....	12
Typical Electro-Optical Characteristics Curves.....	13~16
Moisture Resistant Packing&Reel Dimension.....	17
Carrier Tape Dimensions.....	18
Moisture Resistant Packing Process.....	18
Recommend Reflow Soldering Profile.....	19
Reliability Test Items and Conditions.....	20
LED Precautions for use.....	21~24

Product Code Description

A F-38/B 4 A 3 6000 F J

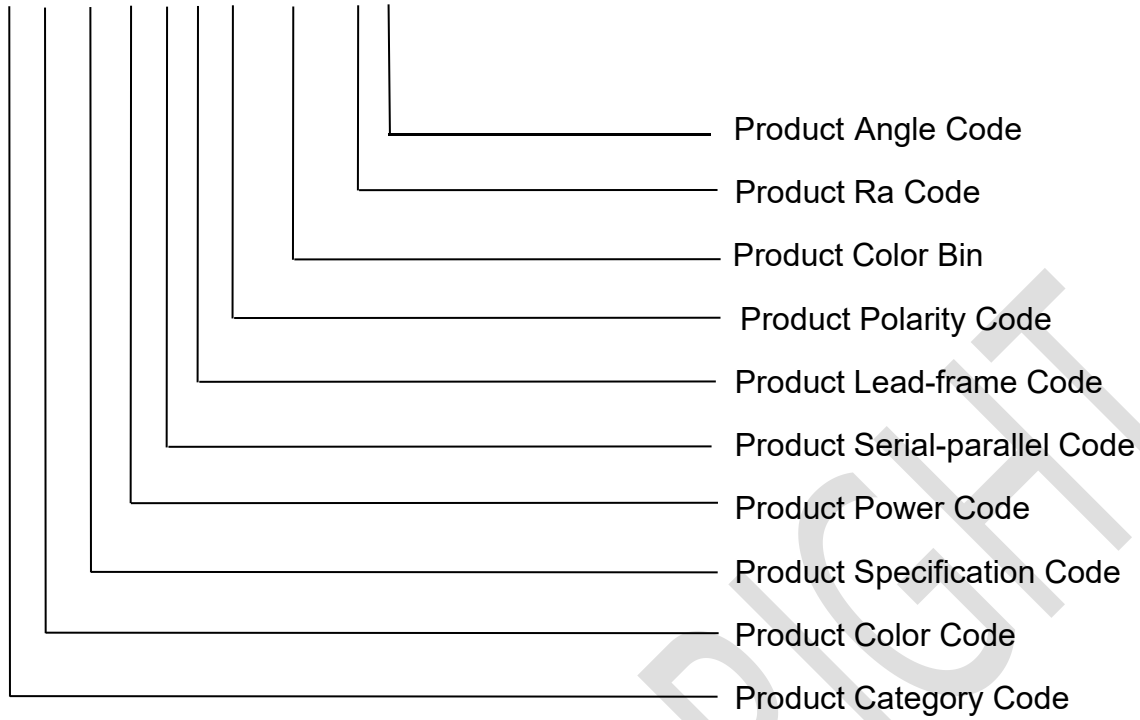

Package Dimension

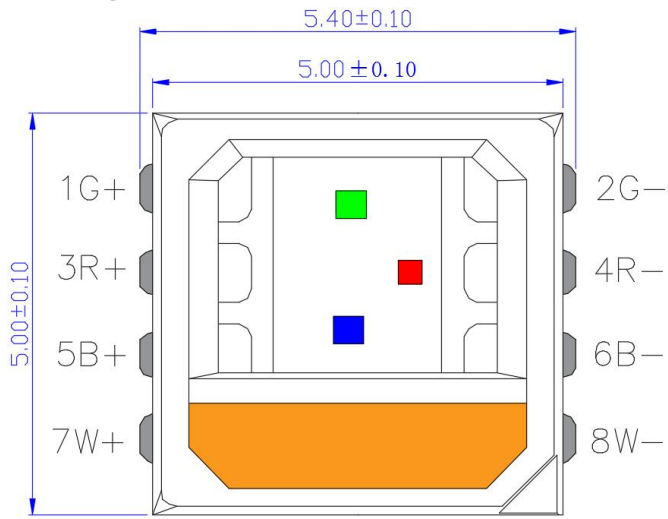

Top View

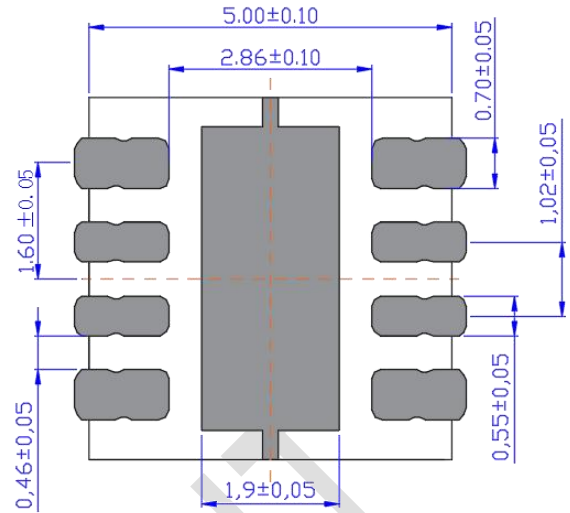

Bottom View

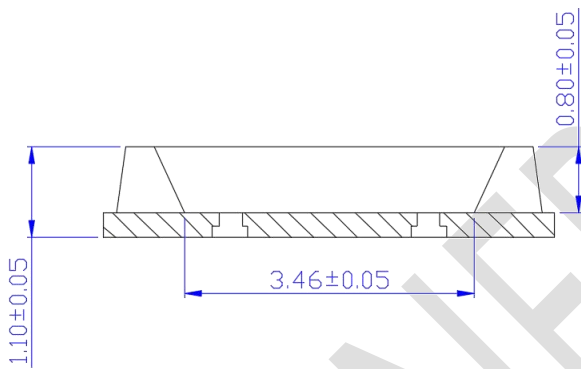

Side View

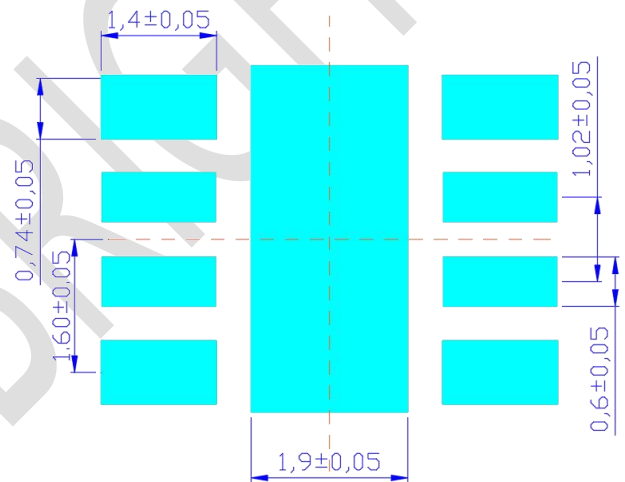

Recommended PCB solder PAD

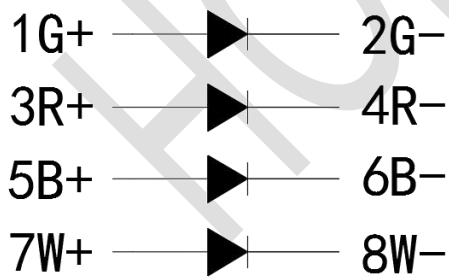

Circuit diagram

Notes:

- 1.All dimensions are in millimeters.
- 2.Tolerance is ± 0.1 unless otherwise noted.
- 3.Specifications are subject to change without notice.

Absolute Maximum Ratings (Ta=25°C)

Parameter	Symbol	Condition	Rating	Unit
Forward DC Current	IF	Ta=25°C	R=180mA GBW=250mA	mA
Pulse Forward DC Current	IFP	Ta=25°C Pulse width ≤10ms and duty cycle ≤10%	R=180mA GBW=250mA	mA
Reverse Voltage	VR	Ta=25°C	≤5	V
LED Junction Temperature	Tj	--	≤115	°C
Storage Temperature	Tstg	--	-40~+105	°C
Operating Temperature	Topr	--	-40~+85	°C
Soldering Temperatur	Tsol	Reflow Soldering:260°C for 10 sec. Hand Soldering:350°C for 3 sec.		
HBM ESD Classification	ESD	Class 2 (2000V) (ANSI/ESDA/JEDEC JS-001)		

Electro-Optical Characteristics (Ta=25°C)

Parameter	Symbol	Condition	Min.	Typ.	Max.	Unit
Luminous Flux (mcd/lm)	Red	IF=180mA	--	30	--	lm
	Green	IF=250mA	--	80	--	
	Blue	IF=250mA	--	18	--	
	W	IF=250mA	--	110	--	
Wavelength / TC	Red	IF=180mA	--	620	--	nm
	Green	IF=250mA	--	521	--	
	Blue	IF=250mA	--	464	--	
	W	IF=250mA	--	6000	--	K
Forward Voltage	Red	IF=180mA	--	2.1	--	V
	Green	IF=250mA	--	3.0	--	
	Blue	IF=250mA	--	3.0	--	
	W	IF=250mA	--	2.8	--	
Viewing Angle	2θ1/2	IF=180mA*4	--	120	--	deg
Reverse Current	IR	VR=5V	--	--	3	uA
Thermal resistance,junction to solder point	Rth	IF=180mA*4	--	25	--	°C/W
Color Rendering Index (W)	Ra	IF=250mA	--	80	--	--
Chromaticity Coordinates (W)	X	IF=250mA	--	0.3233	--	--
	Y		--	0.3330	--	

Notes:

- Tolerance of Luminous intensity: ±10%.
- Tolerance of Forward Voltage: ±0.1V , WLD:±1nm.
- The products are sensitive to static electricity and must be carefully taken when handling products.

Chromaticity Bins

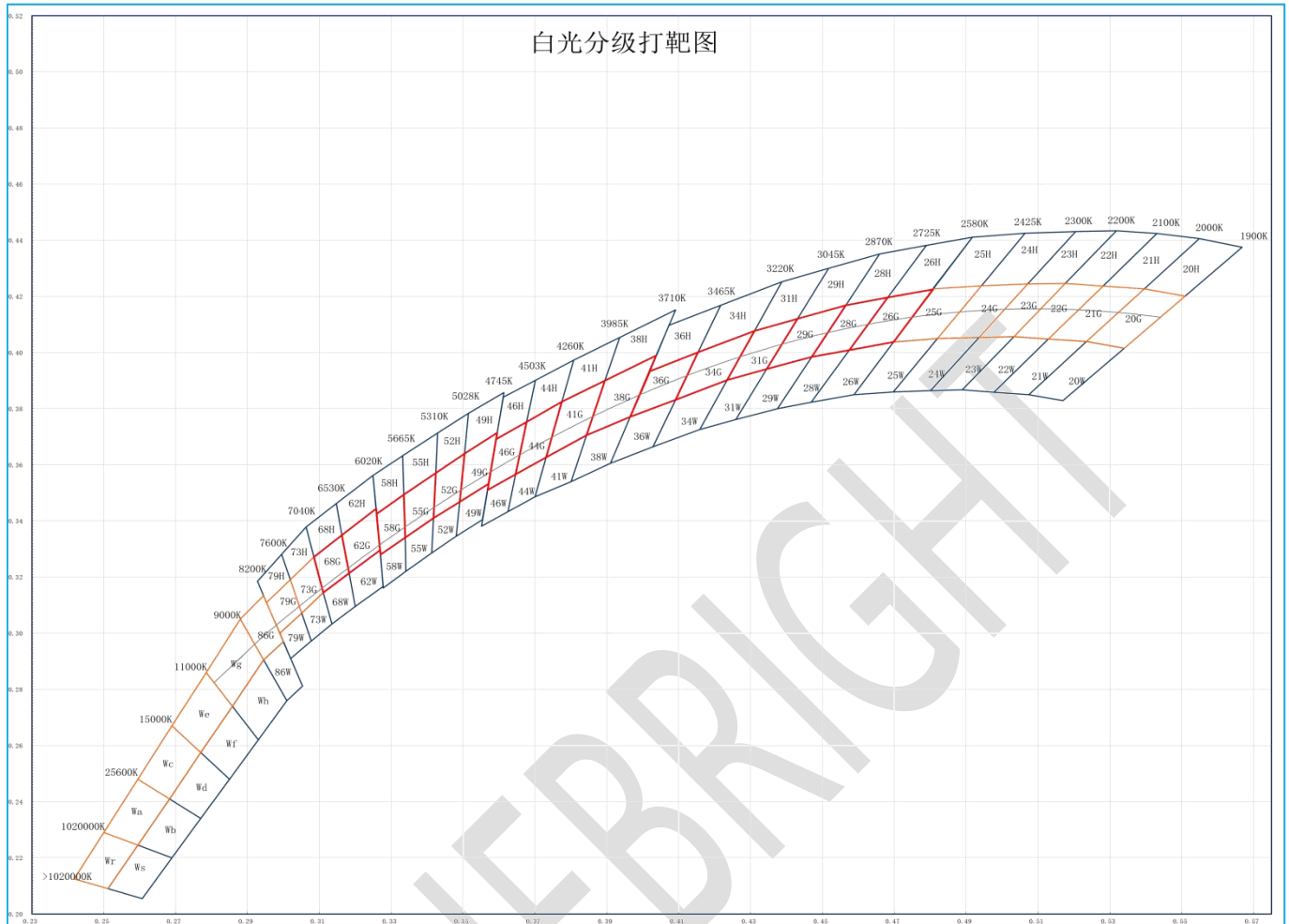

Table Bin Range of Chromaticity Coordinates Block (IF=60mA ;Ta=25°C)

BIN CODE	X	Y	BIN CODE	X	Y	BIN CODE	X	Y
20H	0.5346	0.4227	20G	0.5185	0.4039	20W	0.5024	0.3850
	0.5499	0.4406		0.5346	0.4227		0.5185	0.4039
	0.5618	0.4375		0.5459	0.4201		0.5290	0.4015
	0.5459	0.4201		0.5290	0.4015		0.5119	0.3829
21H	0.5231	0.4237	21G	0.5079	0.4048	21W	0.4927	0.3859
	0.5381	0.4424		0.5231	0.4237		0.5079	0.4048
	0.5499	0.4406		0.5346	0.4227		0.5185	0.4039
	0.5346	0.4227		0.5185	0.4039		0.5024	0.3850
22H	0.5126	0.4246	22G	0.4983	0.4057	22W	0.4839	0.3867
	0.5268	0.4434		0.5126	0.4246		0.4983	0.4057
	0.5381	0.4424		0.5231	0.4237		0.5079	0.4048
	0.5231	0.4237		0.5079	0.4048		0.4927	0.3859

BIN CODE	X	Y	BIN CODE	X	Y	BIN CODE	X	Y
23H	0.5021	0.4244	23G	0.4886	0.4054	23W	0.4751	0.3864
	0.5155	0.4431		0.5021	0.4244		0.4886	0.4054
	0.5268	0.4434		0.5126	0.4246		0.4983	0.4057
	0.5126	0.4246		0.4983	0.4057		0.4839	0.3867
24H	0.4892	0.4238	24G	0.4770	0.4050	24W	0.4647	0.3860
	0.5014	0.4425		0.4892	0.4238		0.4770	0.4050
	0.5155	0.4431		0.5021	0.4244		0.4886	0.4054
	0.5021	0.4244		0.4886	0.4054		0.4751	0.3864
25H	0.4757	0.4227	25G	0.4648	0.4038	25W	0.4538	0.3850
	0.4867	0.4411		0.4757	0.4227		0.4648	0.4038
	0.5014	0.4425		0.4892	0.4238		0.4770	0.4050
	0.4892	0.4238		0.4770	0.4050		0.4647	0.3860
26H	0.4632	0.4196	26G	0.4525	0.4009	26W	0.4419	0.3823
	0.4739	0.4382		0.4632	0.4196		0.4525	0.4009
	0.4867	0.4411		0.4758	0.4225		0.4648	0.4038
	0.4758	0.4226		0.4648	0.4038		0.4538	0.3850
28H	0.4515	0.4168	28G	0.4420	0.3985	28W	0.4325	0.3800
	0.4609	0.4351		0.4515	0.4168		0.4420	0.3985
	0.4739	0.4382		0.4632	0.4196		0.4525	0.4009
	0.4632	0.4196		0.4525	0.4009		0.4419	0.3823
29H	0.4381	0.4120	29G	0.4295	0.3941	29W	0.4209	0.3761
	0.4467	0.4300		0.4381	0.4120		0.4295	0.3941
	0.4609	0.4351		0.4515	0.4168		0.4420	0.3985
	0.4515	0.4168		0.4420	0.3985		0.4325	0.3800
31H	0.4261	0.4077	31G	0.4185	0.3902	31W	0.4109	0.3726
	0.4337	0.4252		0.4261	0.4077		0.4185	0.3902
	0.4467	0.4300		0.4381	0.4120		0.4295	0.3941
	0.4381	0.4120		0.4295	0.3941		0.4209	0.3761
34H	0.4104	0.4001	34G	0.4041	0.3832	34W	0.3978	0.3664
	0.4167	0.4168		0.4104	0.4001		0.4041	0.3832
	0.4337	0.4252		0.4261	0.4077		0.4185	0.3902
	0.4261	0.4077		0.4185	0.3902		0.4109	0.3726
36H	0.3970	0.3934	36G	0.3915	0.3771	36W	0.3860	0.3606
	0.4023	0.4097		0.3970	0.3934		0.3915	0.3771
	0.4167	0.4168		0.4104	0.4001		0.4041	0.3832
	0.4104	0.4001		0.4041	0.3832		0.3978	0.3664

BIN CODE	X	Y	BIN CODE	X	Y	BIN CODE	X	Y
38H	0.3845	0.3900	38G	0.3794	0.3706	38W	0.3751	0.3540
	0.3886	0.4054		0.3845	0.3900		0.3794	0.3706
	0.4041	0.4152		0.3987	0.3989		0.3915	0.3771
	0.3987	0.3989		0.3915	0.3771		0.3860	0.3606
41H	0.3725	0.3825	41G	0.3681	0.3627	41W	0.3650	0.3486
	0.3758	0.3973		0.3725	0.3825		0.3681	0.3627
	0.3886	0.4054		0.3845	0.3900		0.3794	0.3706
	0.3845	0.3900		0.3794	0.3706		0.3751	0.3540
44H	0.3627	0.3753	44G	0.3596	0.3566	44W	0.3575	0.3433
	0.3651	0.3901		0.3627	0.3753		0.3596	0.3566
	0.3758	0.3973		0.3725	0.3825		0.3681	0.3627
	0.3725	0.3825		0.3681	0.3627		0.3650	0.3486
46H	0.3542	0.3691	46G	0.3518	0.3510	46W	0.3501	0.3381
	0.3562	0.3841		0.3542	0.3691		0.3518	0.3510
	0.3651	0.3901		0.3627	0.3753		0.3596	0.3566
	0.3627	0.3753		0.3596	0.3566		0.3575	0.3433
49H	0.3454	0.3640	49G	0.3441	0.3468	49W	0.3431	0.3346
	0.3465	0.3784		0.3454	0.3640		0.3441	0.3468
	0.3564	0.3858		0.3545	0.3714		0.3521	0.3532
	0.3545	0.3714		0.3521	0.3532		0.3504	0.3404
52H	0.3374	0.3571	52G	0.3368	0.3410	52W	0.3363	0.3286
	0.3379	0.3713		0.3374	0.3571		0.3368	0.3410
	0.3465	0.3784		0.3454	0.3640		0.3441	0.3468
	0.3454	0.3640		0.3441	0.3468		0.3431	0.3346
55H	0.3285	0.3494	55G	0.3289	0.3341	55W	0.3291	0.3221
	0.3282	0.3632		0.3285	0.3494		0.3289	0.3341
	0.3379	0.3713		0.3374	0.3571		0.3368	0.3410
	0.3374	0.3571		0.3368	0.3410		0.3363	0.3286
58H	0.3209	0.3425	58G	0.3220	0.3280	58W	0.3228	0.3161
	0.3199	0.3562		0.3209	0.3425		0.3220	0.3280
	0.3282	0.3632		0.3285	0.3494		0.3289	0.3341
	0.3285	0.3494		0.3289	0.3341		0.3291	0.3221
62H	0.3113	0.3350	62G	0.3133	0.3214	62W	0.3150	0.3096
	0.3097	0.3462		0.3113	0.3350		0.3133	0.3214
	0.3199	0.3562		0.3208	0.3444		0.3219	0.3296
	0.3208	0.3444		0.3219	0.3296		0.3228	0.3167
68H	0.3035	0.3272	68G	0.3061	0.3145	68W	0.3085	0.3033
	0.3013	0.3378		0.3035	0.3272		0.3061	0.3145
	0.3097	0.3462		0.3113	0.3350		0.3133	0.3214
	0.3113	0.3350		0.3133	0.3214		0.3150	0.3096

BIN CODE	X	Y	BIN CODE	X	Y	BIN CODE	X	Y
73H	0.2969	0.3191	73G	0.3001	0.3072	73W	0.3028	0.2972
	0.2945	0.3281		0.2969	0.3191		0.3001	0.3072
	0.3013	0.3378		0.3035	0.3272		0.3061	0.3145
	0.3035	0.3272		0.3061	0.3145		0.3085	0.3033
79H	0.2903	0.3109	79G	0.2940	0.3000	79W	0.2970	0.2910
	0.2878	0.3185		0.2903	0.3109		0.2940	0.3000
	0.2945	0.3281		0.2969	0.3191		0.3001	0.3072
	0.2969	0.3191		0.3001	0.3072		0.3028	0.2972
86G	0.2895	0.2905	86W	0.2960	0.2760	Wg	0.2808	0.2740
	0.2830	0.3050		0.2895	0.2905		0.2735	0.2860
	0.2895	0.3134		0.2950	0.2970		0.2830	0.3050
	0.2950	0.2970		0.3003	0.2812		0.2895	0.2905
Wh	0.2880	0.2620	We	0.2720	0.2575	Wf	0.2800	0.2480
	0.2808	0.2740		0.2640	0.2670		0.2720	0.2575
	0.2895	0.2905		0.2735	0.2860		0.2808	0.2740
	0.2960	0.2760		0.2808	0.2740		0.2880	0.2620
Wc	0.2633	0.2410	Wd	0.2720	0.2340	Wa	0.2545	0.2245
	0.2545	0.2480		0.2633	0.2410		0.2450	0.2290
	0.2640	0.2670		0.2720	0.2575		0.2545	0.2480
	0.2720	0.2575		0.2800	0.2480		0.2633	0.2410
Wb	0.2640	0.2200	Wr	0.2462	0.2090	Ws	0.2557	0.2055
	0.2545	0.2245		0.2368	0.2125		0.2462	0.2090
	0.2633	0.2410		0.2450	0.2290		0.2545	0.2245
	0.2720	0.2340		0.2545	0.2245		0.2640	0.2200

Notes 备注:

1. Measurement uncertainty of the color coordinates: ± 0.003 .

Brightness Groups R:180mA/GBW=250mA

Bin Code	Luminous Flux min.(LM)	Luminous Flux max.(LM)
43	25	30
44	30	35
45	35	40
57	75	85
58	85	95
59	95	105
03	10	15
04	15	20
05	20	25
95	90	100
105	100	110
115	110	120
125	120	130

Forward Voltage Groups R:180mA/GBW=250mA

Group	Forward Voltage min.(v)	Forward Voltage max.(v)
F35	1.8	2.0
F36	2.0	2.2
F37	2.2	2.4
F38	2.4	2.6
F40	2.8	3.0
F41	3.0	3.2
F42	3.2	3.4
F43	3.4	3.6
F40	2.8	3.0
F41	3.0	3.2
F42	3.2	3.4
F43	3.4	3.6
F40	2.8	3.0
F41	3.0	3.2
F42	3.2	3.4
F43	3.4	3.6

Wavelength Groups R:180mA/GBW=250mA

Group	Wavelength min.(nm)	Wavelength max.(nm)
R10	615	620
R20	620	625
R30	625	630
G40	515	520
G50	520	525
G60	525	530
B60	455	460
B70	460	465
B80	465	470

Table of Color Rendering Index R:180mA/GBW=250mA

Symbol	Description
A	CRI(Min.): No Requirement
F	CRI(Min.): 80

Notes:

- 1.Tolerance of Luminous flux: $\pm 10\%$.
- 2.Tolerance of Forward Voltage: $\pm 0.1V$.
- 3.Tolerance of Wavelength: $\pm 1nm$

Typical Electro-Optical Characteristics Curves (Ta=25°C)

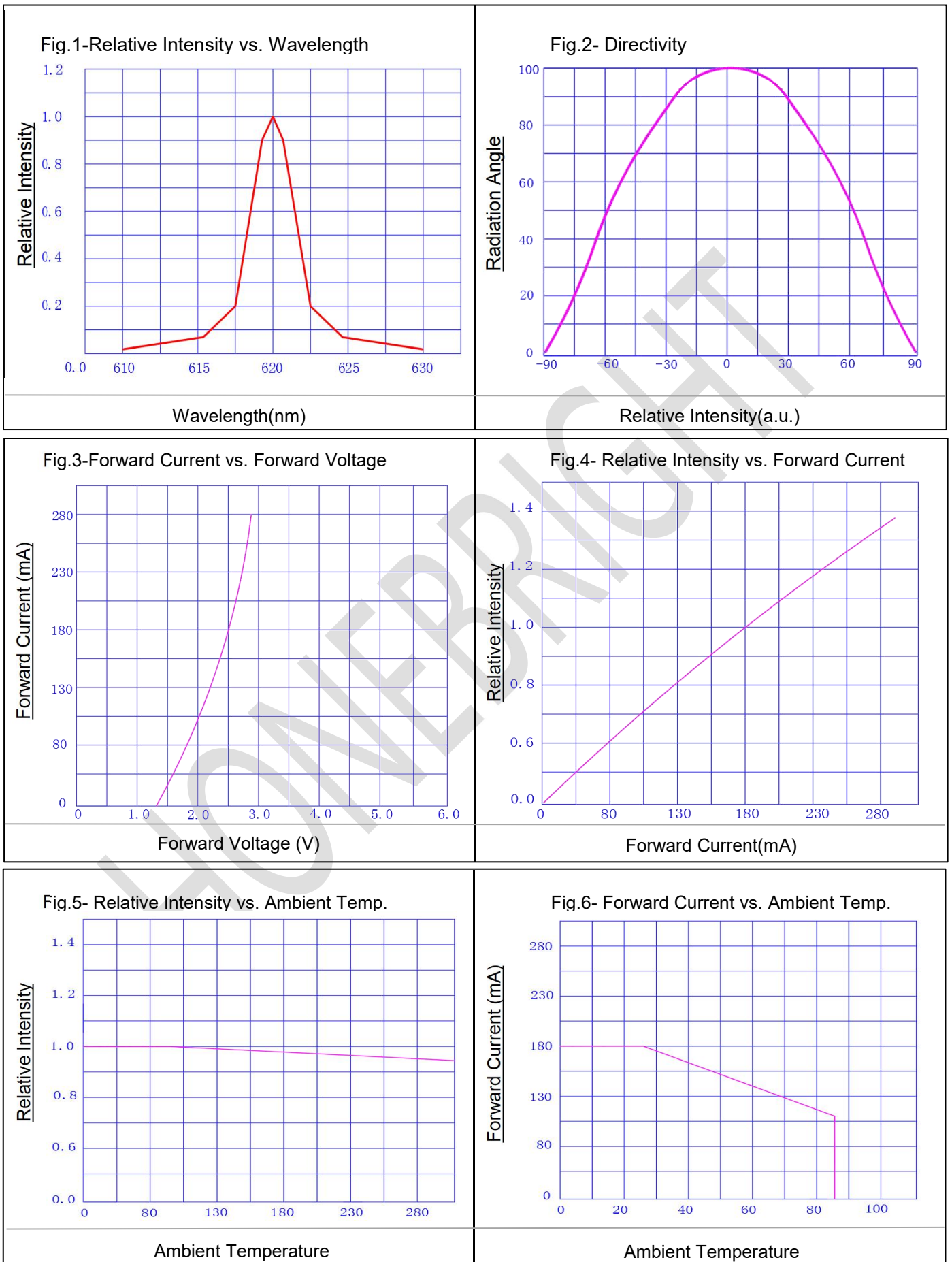

Typical Electro-Optical Characteristics Curves (Ta=25°C)

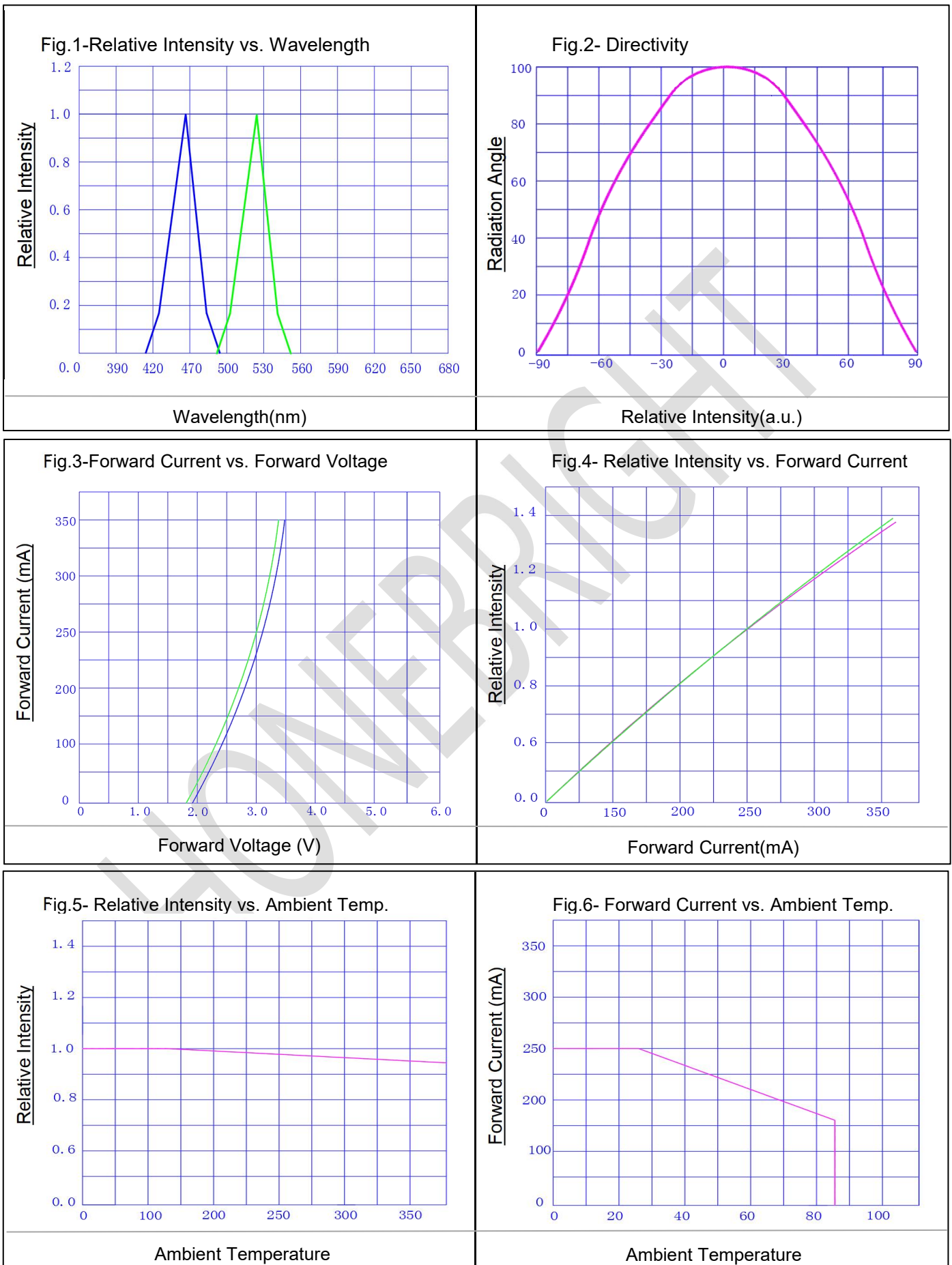

Typical Electro-Optical Characteristics Curves Of White (Ta=25°C)

Fig.1-Spectrum Distribution

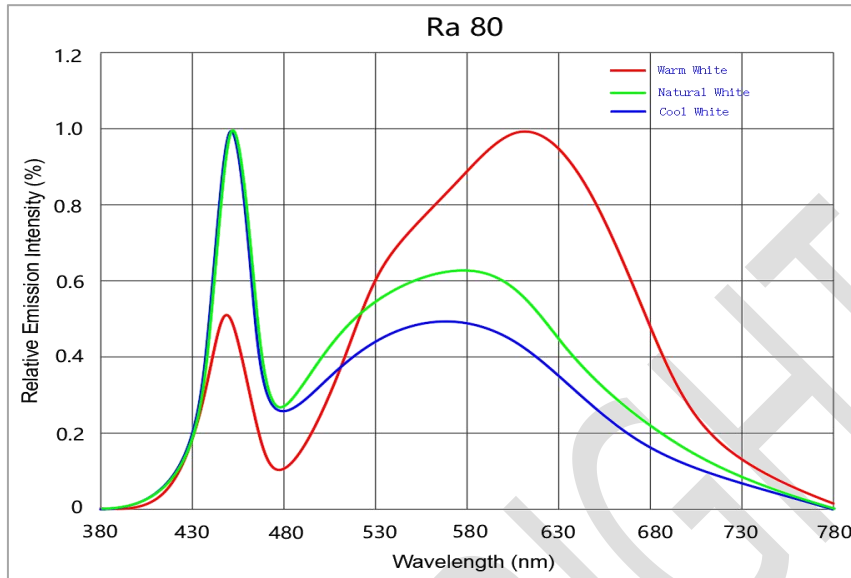

Typical Electro-Optical Characteristics Curves Of White (Ta=25°C)

Fig.2- Forward Current vs. Ambient Temp

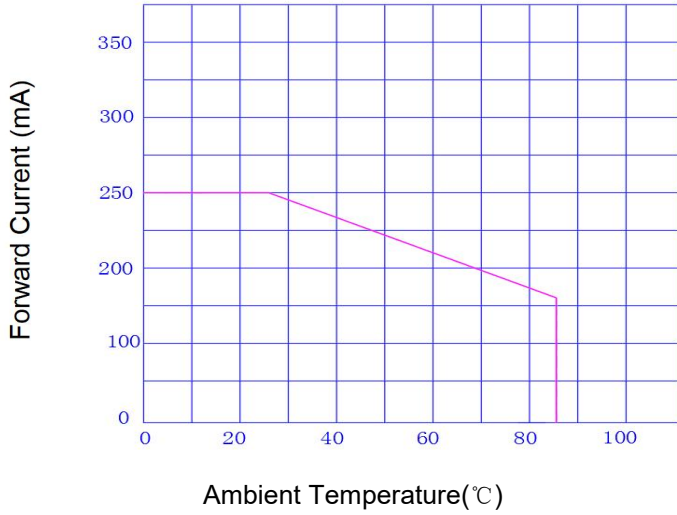

Fig.3-Forward Current vs. Forward Voltage

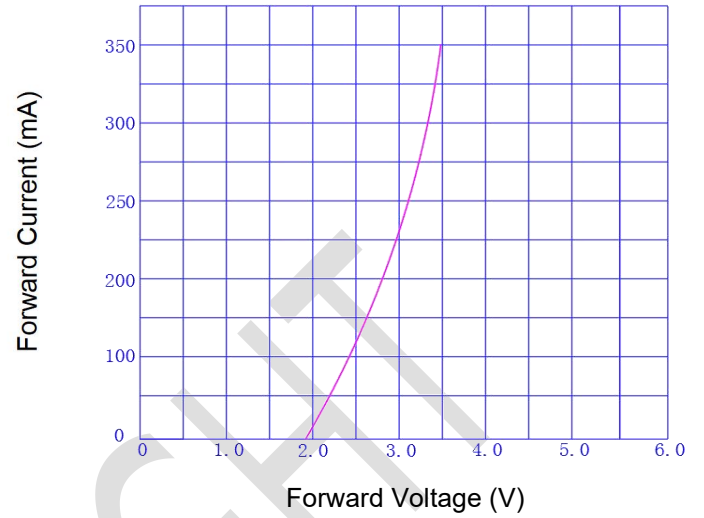

Fig.4- Relative Intensity vs. Forward Current

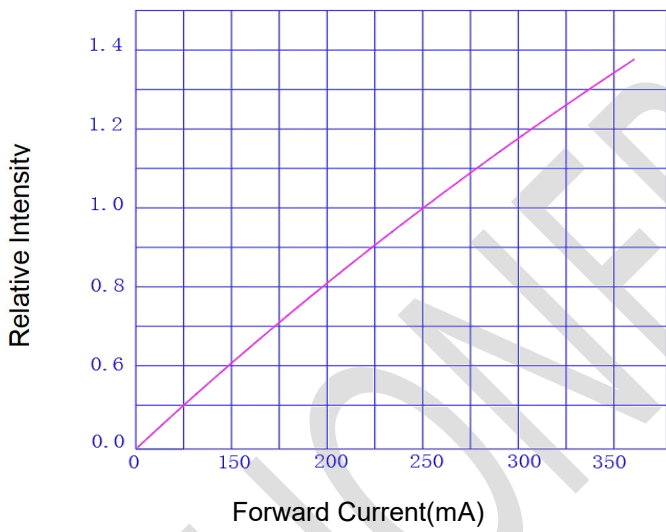

Fig.5- Relative Intensity vs. Ambient Temp.

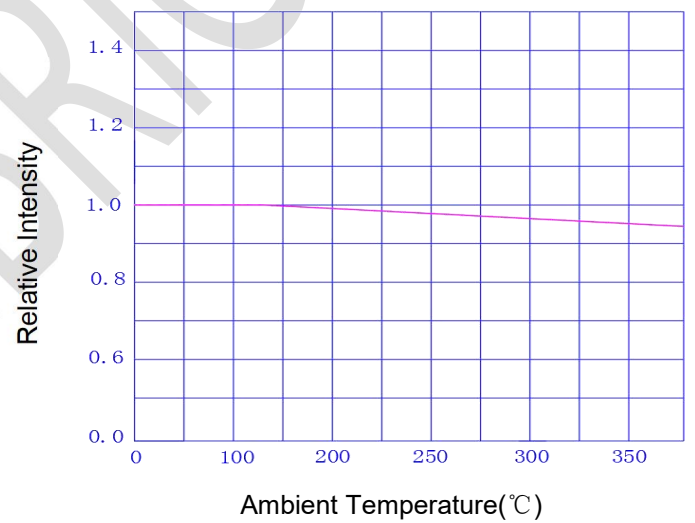

Fig.6- Relative Forward Voltage vs. Temperature

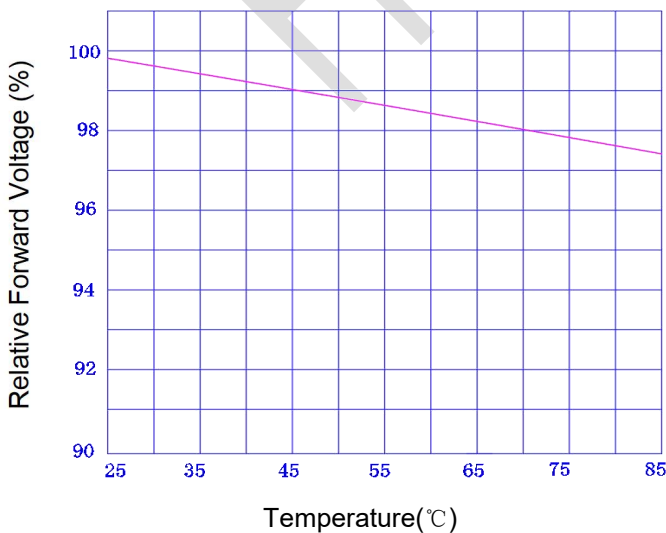
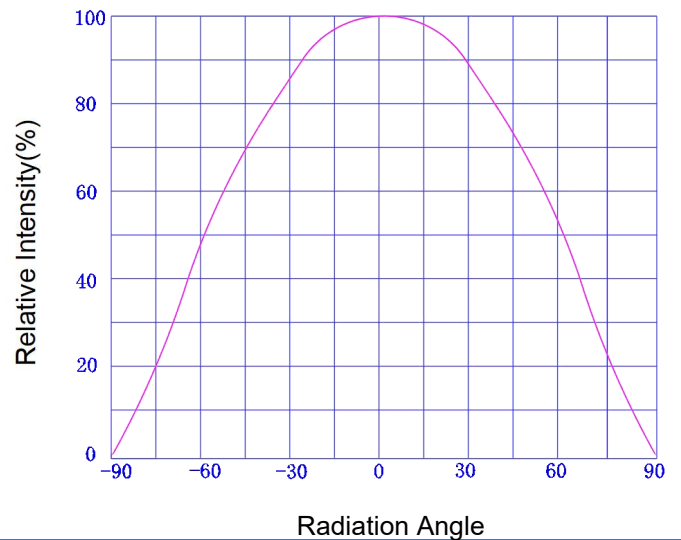
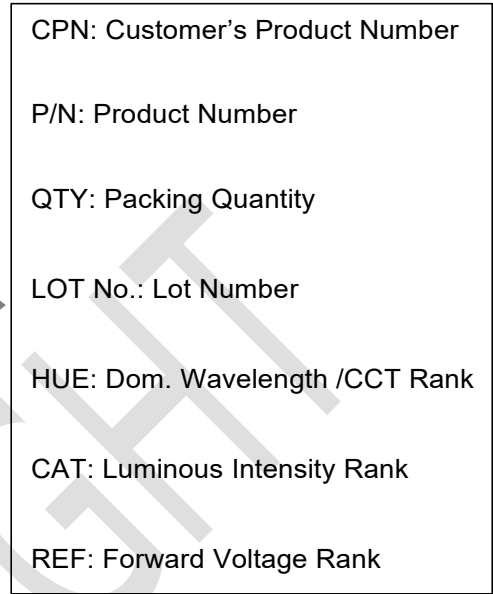

Fig.7- Directivity



Moisture Resistant Packing

Label Explanation



Reel Dimensions

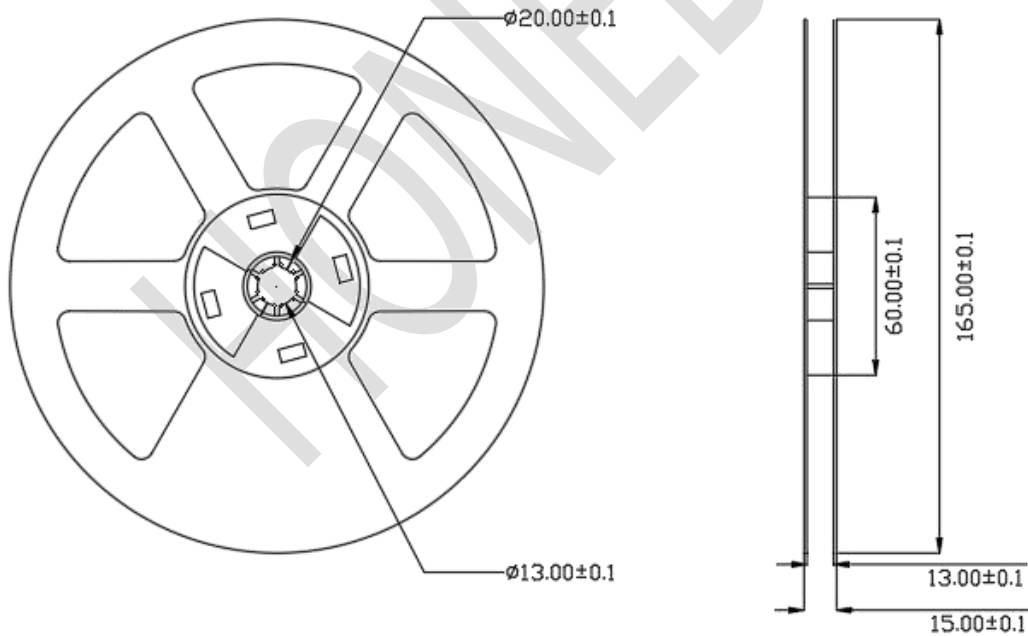

Note:

Tolerances unless mentioned ± 0.1 mm. Unit = mm.

Carrier Tape Dimensions:

Loaded Quantity : 1000 pcs Per Reel

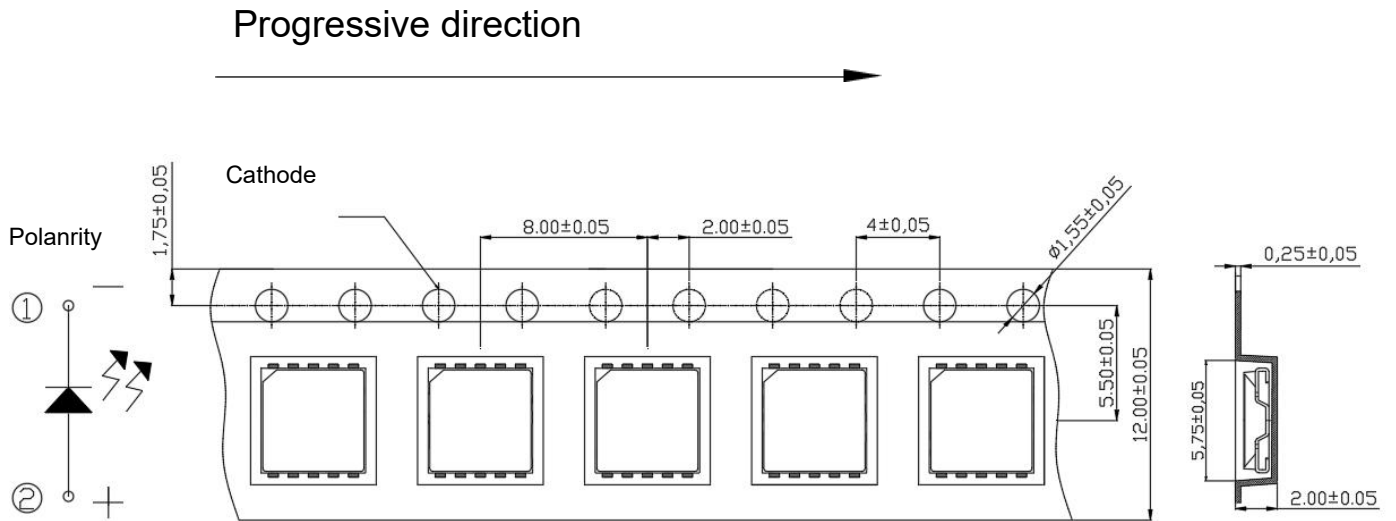

Note:

1. Tolerance unless mentioned is $\pm 0.1\text{mm}$; Unit = mm..

Moisture Resistant Packing Process

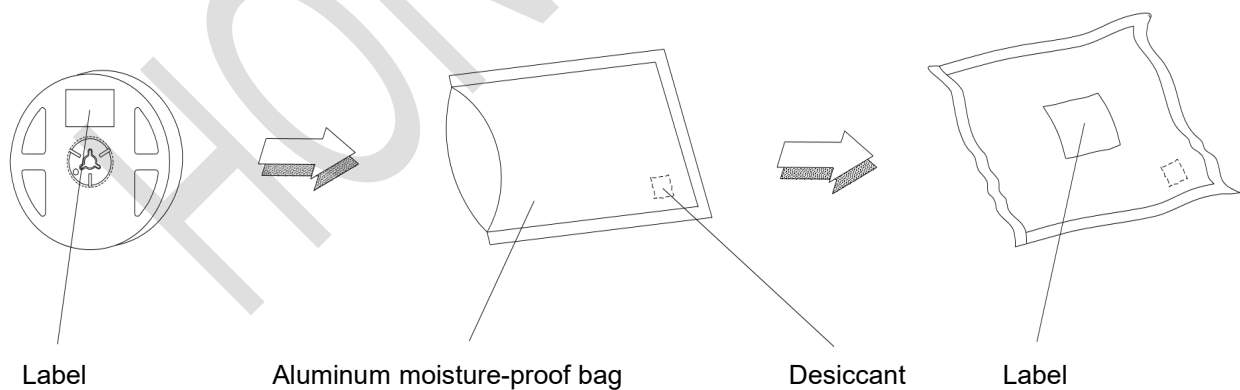

Recommend Reflow Soldering Profile

Lead Free Solder

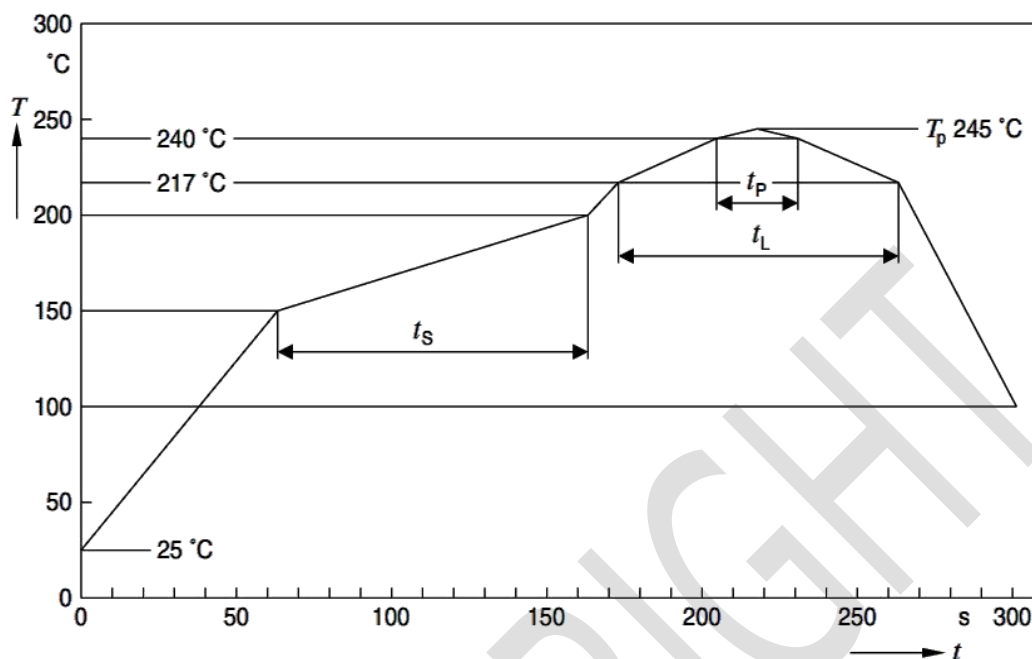

Profile Feature Profil-Charakteristik	symbol	Pb-Free(SnAgCu) Assembly			Unit Einheit
		Minimum	Recommendation	Maximum	
Ramp-up rate to preheat 25°C to 150°C			2	3	k/s
Time ts Ts min to Ts max	ts	60	100	120	s
Ramp-up rate to peak Ts max to Tp			2	3	k/s
Liquidus temperature	tL	217			°C
Time above liquidus temperature	tL		80	100	s
Peak temperature	Tp		240	245	°C
Time within 5°C of the specified peak temperature Tp		10	20	30	s
Ramp-down rate Tp to 100°C			3	6	k/s
Time 25°C to Tp				480	s

Notes:

1. All temperatures refer to the center of the package, measured on the top of the component.
2. When soldering, do not put stress on the LEDs during heating.
3. After soldering, do not warp the circuit board.
4. Reflow soldering should not be done more than two times.

Reliability Test Items and Conditions

- ① The products shall be satisfied tests as listed below.
- ② Confidence level: 90%.
- ③ LTPD: 10%.

NO.	Test Item	Test Condition	Reference Standard	Note	Number of Damaged
1	Resistance to Soldering Heat (Reflow Soldering)	Tsld=260°C, 10sec. (Precondition 30°C,70%RH,168hr.)	JEITA ED-4701 300 301	3 times	0/22
2	Solderability (Reflow Soldering)	Tsld=245±5°C, 5sec. (Lead Free Solder)	JEITA ED-4701 300 303	3 times	0/22
3	Thermal Shock	-30°C ~ 85°C 30min~ 30min.	JEITA ED-4701 300 307	100 cycles	0/22
4	Temperature Cycle	-40°C ~ 25°C ~ 105°C ~ 25°C 30min~5min~ 30min~ 5min.	JEITA ED-4701 100 105	100 cycles	0/22
5	High Temperature Storage	Ta=100°C	JEITA ED-4701 200 201	1000 hrs.	0/22
6	Temperature Humidity Storage	Ta=60°C, RH=90%	JEITA ED-4701 100 103	1000 hrs.	0/22
7	Low Temperature Storage	Ta=-40°C	JEITA ED-4701 200 202	1000 hrs.	0/22
8	Steady State Operating Life Condition	Ta=25°C, R=180mA GBW=250mA		1000 hrs.	0/22
9	Steady State Operating Life of High Temperature	Ta=85°C, R=180mA GBW=250mA		1000 hrs.	0/22
10	Steady State Operating Life of High Humidity Heat	60°C, RH=90%, R=180mA GBW=250mA		1000 hrs.	0/22
11	Steady State Operating Life of low Temperature	Ta=-30°C, R=180mA GBW=250mA		1000 hrs.	0/22

LED Precautions for use

1. Storage

Conditions		Temperature	Humidity	Time
Storage	Before Opening Aluminum Bag	≤30℃	≤90%RH	Within 1 Year from Delivery Date
	After Opening Aluminum Bag	≤30℃	≤70%RH	≤24 hours
Baking		65±5℃	--	≥24 hours

- ① The storage/packaging requirements for this LED are comparable to JEDEC Moisture Sensitivity Level (MSL) 3 or equivalent. HoneBright used IPC/JEDEC STD-020 as a reference to rate the MSL of this LED.
- ② This LED uses a package that could absorb moisture; if the package absorbs moisture and is exposed to heat during soldering, it may cause the moisture to vaporize and the package to expand and the resulting pressure may cause internal delamination. This may cause the optical characteristics to degrade. To minimize moisture absorption in storage/transit, moisture-proof aluminum bags are used for the LEDs with a silica gel packet to absorb any air moisture in the bag. The silica gel beads turn blue to red as they absorb moisture.
- ③ Once the moisture-proof aluminum bag is open, ensure that the LED is soldered to a PCB within the range of the conditions above. To store any remaining unused LEDs, use a hermetically sealed container with silica gel desiccants. HoneBright recommends placing them back to the original moisture-proof bag and reseal it.
- ④ If the "After Opening" storage time has been exceeded or any pink silica gel beads are found, ensure that the LED are baked before use. Baking should only be done once.
- ⑤ This LED has silver-plated parts both inside and outside of the package. If the LEDs are exposed to a corrosive environment, it may cause the plated surface to tarnish causing issues (i.e. solderability, optical characteristics). Ensure that when storing LEDs, a hermetically sealed container is used. HoneBright recommends placing them back to the original moisture-proof bag and reseal it.
- ⑥ Ensure that when designing, there are no issues with the parts/materials used with the LEDs. The following must be taken into consideration:
- ⑦ After soldering LEDs to a PCB and/or installing them in a system, it is possible that the LEDs will be exposed to corrosive gases released from parts/materials used with the LEDs in the same assembly/system (e.g. rubber materials, cardboard boxes) and/or gases entering from the outside; the plated surface may tarnish depending on the gas component.
- ⑧ Small amounts of corrosive gas may be found in the air.
- ⑨ Resin materials may contain substances (e.g. halogens) that affect the plated surfaces of the LEDs.
- ⑩ To prevent substances/gases from affecting the plated surface, ensure that the parts/materials used with the LEDs in the same assembly/system do not contain sulfur (e.g. gasket/seal, adhesive, etc.). If the plating becomes extremely corroded or contaminated, it may cause issues (e.g. electrical connection failures). If a gasket/seal is used, silicone rubber gaskets/seals are recommended; ensure that this use of silicone does not result in issues (e.g. electrical connection failures) caused by low molecular weight volatile siloxane.
- ⑪ To avoid condensation, the LEDs must not be stored in areas where temperature and humidity fluctuate greatly.
- ⑫ Do not store the LEDs in a dusty environment.
- ⑬ Do not expose the LEDs to direct sunlight and/or an environment over a long period of time where the temperature is higher than normal room temperature.

2.Directions for Use

- ① The circuit must be designed to ensure that the Absolute Maximum Ratings are not exceeded for each LED. The LEDs should be operated at a constant current per LED. In the case of operating at a constant voltage, Circuit B is

recommended. If Circuit A is used, it may cause the currents flowing through the LEDs to vary due to the variation in the forward voltage characteristics of the LEDs on the circuit.

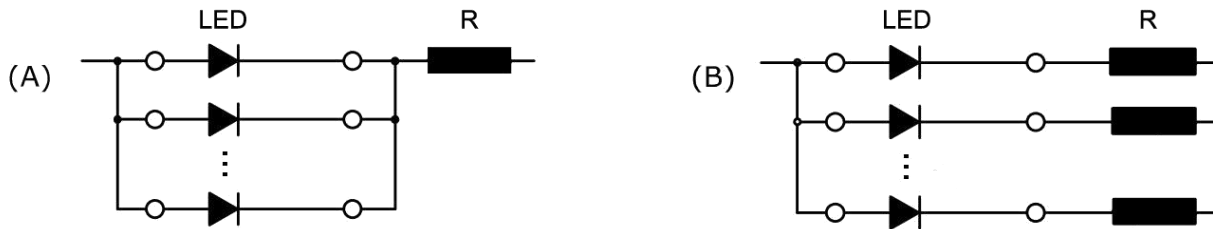

- ② This LED is designed to be operated at a forward current. Ensure that no voltage is applied to the LED in the forward/reverse direction while the LED is off. If the LEDs are used in an environment where reverse voltages are applied to the LED continuously, it may cause electrochemical migration to occur causing the LED to be damaged. When not in use for a long period of time, the system's power should be turned off to ensure that there are no issues/damage.
- ③ To stabilize the LED characteristics while in use, HoneBright recommends that the LEDs are operated at currents $\geq 10\%$ of the sorting current.
- ④ Ensure that transient excessive voltages (e.g. lighting surge) are not applied to the LEDs.
- ⑤ If the LEDs are used for outdoor applications, ensure that necessary measures are taken (e.g. protecting the LEDs from water/salt damage and high humidity).

3. Handling Precautions

- ① Do not handle the LEDs with bare hands:
- ② this may contaminate the LED surface and have an effect on the optical characteristics,
- ③ this may cause the LED to deform and/or the wire to break causing a catastrophic failure (i.e. the LED not to illuminate).
- ④ Ensure that when handling the LEDs with tweezers, excessive force is not applied to the LED. Otherwise, it may cause damage to the resin (e.g. cut, scratch, chip, crack, delamination and deformation) and the wire to break causing a catastrophic failure (i.e. the LED not to illuminate).
- ⑤ Dropping may cause damage to the LED (e.g. deformation).
- ⑥ Do not stack assembled PCBs together. Otherwise, it may cause damage to the resin (e.g. cut, scratch, chip, crack, delamination and deformation) and the wire to break causing a catastrophic failure (i.e. the LED not to illuminate).
- ⑦ CRI Rank R9050 LEDs in this specification use materials that contain halogen-based compounds; the halogen element found in these materials will not affect the LEDs when the LEDs are used under the conditions detailed in this specification. The other CRI ranks in this specification do not use these materials.
- ⑧ Due to the variation in the amount of the reflective material (LED resin) that is coating the protection device, the area around the protection device may appear to be a black spot; this will not affect the characteristics of the LED. Do not use the location of the protection device to determine the polarity of the LED; use the cathode mark.

4. Design Consideration

- ① If the LEDs are soldered to a PCB and the PCB assembly is bent (e.g. PCB depaneling process), it may cause the LED package to break. The PCB layout should be designed to minimize the mechanical stress on the LEDs when the PCB assembly is bent/warped.
- ② The amount of mechanical stress exerted on the LED from depaneling may vary depending on the LED position/orientation on the PCB assembly (e.g. especially in areas near V-groove scores). The PCB layout should be designed to minimize the mechanical stress on the LEDs when the PCB is separated into individual PCB assemblies.
- ③ To separate a PCB populated with the LEDs, use a specially designed tool. Do not break the PCB by hand.
- ④ Volatile organic compounds that have been released from materials present around the LEDs (e.g. housing, gasket/seal, adhesive, secondary lens, lens cover, etc.) may penetrate the LED lens and/or encapsulating resin. If the LEDs are being used in a hermetically sealed environment, these volatile compounds can discolor after being exposed to heat and/or photon energy and it may greatly reduce the LED light output and/or color shift. In this case, ventilating the environment may improve the reduction in light output and/or color shift. Perform a light-up test of the chosen application for optical evaluation to ensure that there are no issues, especially if the LEDs are planned to be

used in a hermetically sealed environment.

5. Electrostatic Discharge (ESD)

① This LED is sensitive to transient excessive voltages (e.g. ESD, lightning surge). If this excessive voltage occurs in the circuit, it may cause the LED to be damaged causing issues (e.g. the LED to become dimmer or not to illuminate [i. e. catastrophic failure]). Ensure that when handling the LEDs, necessary measures are taken to protect them from an ESD discharge. The following examples are recommended measures to eliminate the charge:

- Grounded wrist strap, ESD footwear, clothes, and floors
- Grounded workstation equipment and tools
- ESD table/shelf mat made of conductive materials

② Ensure that all necessary measures are taken to prevent the LEDs from being exposed to transient excessive voltages (e.g. ESD, lightning surge):

- tools (e.g. soldering irons), jigs, and machines that are used are properly grounded
- appropriate ESD materials/equipment are used in the work area
- the system/assembly is designed to provide ESD protection for the LEDs.

③ If the tool/equipment used is an insulator (e.g. glass cover, plastic, etc.), ensure that necessary measures have been taken to protect the LED from transient excessive voltages (e.g. ESD). The following examples are recommended measures to eliminate the charge:

- Dissipating static charge with conductive materials
- Preventing charge generation with moisture
- Neutralizing the charge with ionizers

④ To detect if an LED was damaged by transient excess voltages (i.e. an ESD event during the system's assembly process), perform a characteristics inspection (e.g. forward voltage measurement, light-up test) at low current ($\leq 1\text{mA}$).

⑤ Failure Criteria: $V_F < 4.0\text{V}$ at $I_F = 0.5\text{mA}$

If the LED is damaged by transient excess voltages (e.g. ESD), it will cause:

- the Forward Voltage (VF) to decrease
- the LED not to illuminate at a low current

6. Thermal Management

① The Absolute Maximum junction Temperature (T_j) must not be exceeded under any circumstances. The increase in the temperature of an LED while in operation may vary depending on the PCB thermal resistance and the density of LEDs on the PCB assembly. Ensure that when using the LEDs for the chosen application, heat is not concentrated in an area and properly managed in the system/assembly.

② The operating current should be determined by considering the temperature conditions surrounding the LED (i.e. T_A). Ensure that when operating the LED, proper measures are taken to dissipate the heat.

③ The following equations can be used to calculate the LED temperature (i.e. T_j) once the saturation temperature at the junction has been reached.

$$(1) T_j = T_a + R_{thj-a} * W \quad (2) T_j = T_s + R_{thj-s} * W$$

T_j = LED junction Temperature ($^{\circ}\text{C}$)

T_A = Ambient Temperature ($^{\circ}\text{C}$)

T_s = Soldering Temperature (Cathode Side) ($^{\circ}\text{C}$)

R_{thj-a} = Thermal Resistance from junction to Ambient ($^{\circ}\text{C}/\text{W}$)

R_{thj-s} = Thermal Resistance from Junction to T_s Measurement Point ($^{\circ}\text{C}/\text{W}$)

W = Input Power ($I_F * V_F$) (W)

T_s Measurement Point

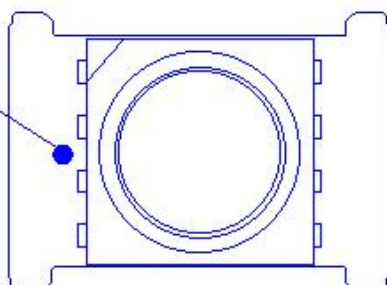

7.Cleaning

- ① Do not wipe/clean the LEDs with a damp cloth soaked in water or solvents (e.g. benzene, thinner, etc.).
- ② If required, use isopropyl alcohol (IPA). If water or other solvent is used, it may cause issues. Before using the solvent, ensure that sufficient verification is performed to ensure that the solvent does not adversely affect the LEDs. In addition, the use of CFCs such as Freon is heavily regulated.
- ③ When a foreign substance (e.g. dust, debris, loose materials, etc.) adheres to the LEDs, wipe it off with a damp well squeezed cloth that was soaked only in isopropyl alcohol (IPA).
- ④ Do not wipe the emitting surface. Otherwise, it may result in excessive pressure to the emitting surface causing issues (e.g. wire to deform, the encapsulating resin to become damaged, the color to change, etc.). If wiping the emitting surface is necessary, ensure that sufficient preliminary verification is performed to ensure that there are no issues; wipe the emitting surface at the customer's risk.
- ⑤ Do not clean the LEDs with an ultrasonic cleaner. If cleaning must be done, ensure that sufficient verification is performed by using a finished assembly with LEDs to determine cleaning conditions (e.g. ultrasonic power, LED position on the PCB assembly) that do not cause an issue.

8.Eye Safety

- ① There may be two important international specifications that should be noted for safe use of the LEDs: IEC 62471:2006 Photobiological safety of lamps and lamp systems and IEC 60825-1:2001 (i.e. Edition 1.2) Safety of Laser Products - Part 1 : Equipment Classification and Requirements. Ensure that when using the LEDs, there are no issues with the following points:
 - LEDs have been removed from the scope of IEC 60825- 1 since IEC 60825-1:2007 (i.e. Edition 2.0) was published. However, depending on the country/region, there are cases where the requirements of the IEC 60825- 1 :2001 specifications or equivalent must be adhered to.
 - LEDs have been included in the scope of IEC 62471: 2006 since the release of the specification in 2006.
 - Most HoneBright LEDs will be classified as the Exempt Group or Risk Group 1 according to IEC 62471: 2006. However, in the case of high-power LEDs containing blue wavelengths in the emission spectrum, there are LEDs that will be classified as Risk Group 2 depending on the characteristics (e.g. radiation flux, emission spectrum, directivity, etc.)
 - If the LED is used in a manner that produces an increased output or with an optic to collimate the light from the LED, it may cause damage to the human eye.
 - If an LED is operated in a manner that emits a flashing light, it may cause health issues (e.g. visual stimuli causing eye discomfort). The system should be designed to ensure that there are no harmful effects on the human body.

9.Miscellaneous

- ① HoneBright warrants that the discrete LEDs will meet the requirements/criteria as detailed in the Reliability section within this specification. If the LEDs are used under conditions/environments deviating from or inconsistent with those described in this specification, the resulting damage and/or injuries will not be covered by this warranty.
- ② HoneBright warrants that the discrete LEDs manufactured and/or supplied by HoneBright will meet the requirements/criteria as detailed in the Reliability section within this specification; it is the customer's responsibility to perform sufficient verification prior to use to ensure that the lifetime and other quality characteristics required for the intended use are met.
- ③ The applicable warranty period is one year from the date that the LED is delivered.
- ④ This LED is intended to be used for general lighting, household appliances, electronic devices (e.g. mobile communication devices); it is not designed or manufactured for use in applications that require safety critical functions (e.g. aircraft, automobiles, combustion equipment, life support systems, nuclear reactor control system, safety devices, spacecraft, submarine repeaters, traffic control equipment, trains, vessels, etc.).
- ⑤ Both the customer and HoneBright will agree on the official specifications for the supplied LEDs before any programs are officially launched. Without this agreement in writing (i.e. Customer Specific Specification), changes to the content of this specification may occur without notice (e.g. changes to the foregoing specifications and appearance, discontinuation of the LEDs, etc.).